

HITACHI
Inspire the Next

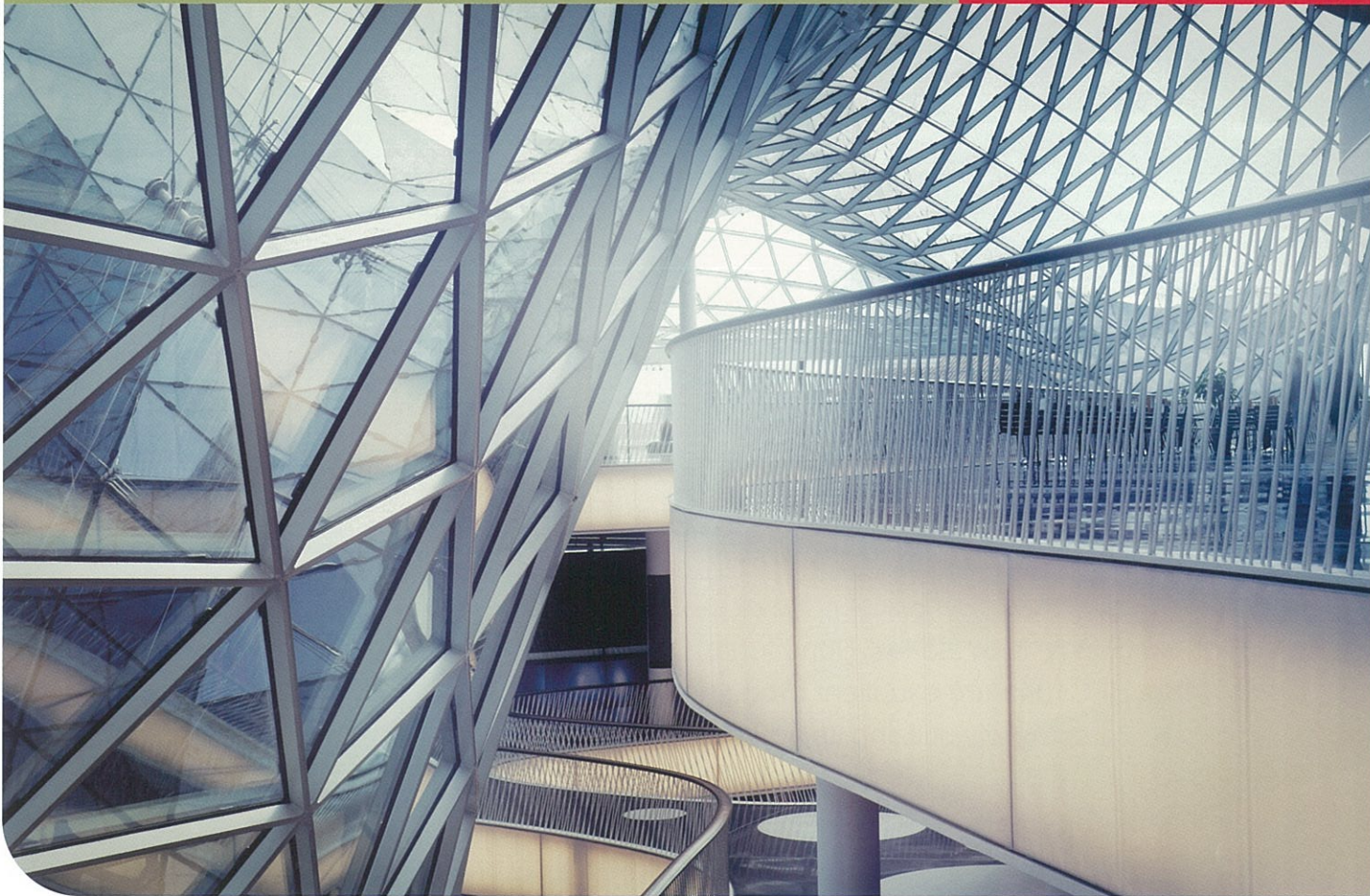

Featuring Ozone-safe **HFC134a**

Hitachi **Centrifugal Chillers**

NEW
GXG-S Series
GSG-S Series
Debut

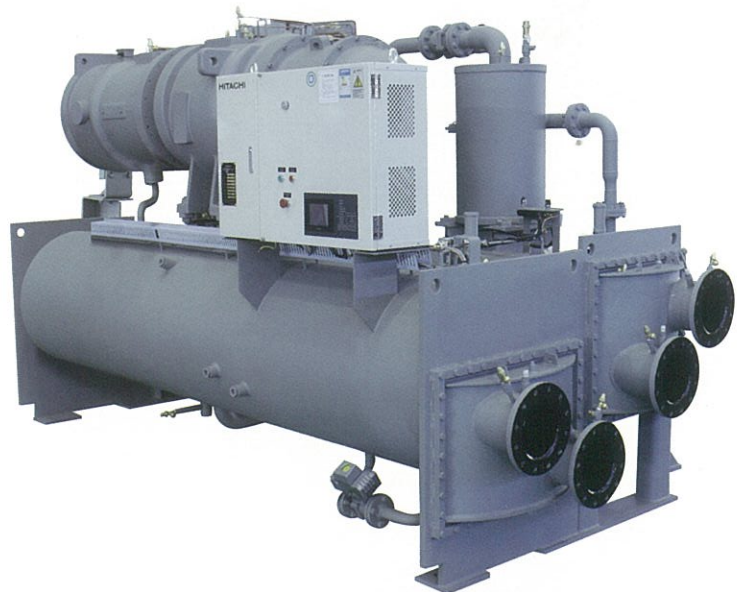

Centrifugal Chiller

New **GXG-S, GSG-S Series** Debut

High-efficiency New series Centrifugal Chillers that use HFC134a are excellent products developed by Hitachi, fully utilizing its advanced technology and rich experience. They are active throughout the world due to their high reputation and excellent performance.

Advantages

■ Excellent Energy-Saving Effect

First class efficiency greatly contributes energy saving of users.

■ Compact Design

Significantly compact and light weight design enables space saving and easy replacement.

■ High Reliability

Hitachi's unique technologies enhance high reliability and long term stable operation.





Global Warming Prevention

Energy saving by high-efficiency centrifugal chillers

Global warming refers to the phenomenon of global rising in average atmospheric temperatures due to increased volume of CO₂ and methane as a result of burning fossil fuels such as petroleum and coal. The 1995 IPCC* Report predicted that if the emission of CO₂, etc. continued as it was, the atmospheric temperature would rise by as much as 2°C by the end of the 21st century and, as a result, the sea level would rise by approximately 50 cm from the present level. In such circumstances, it is even more important to save the energy consumed by air conditioners in order to cut CO₂ emission.

* IPCC: Intergovernmental Panel on Climate Change

Hitachi's Key Technologies Realizing High-Efficiency.

High-efficiency Refrigerant Cycle

Increased refrigerating cycle efficiency

- 2 stages compression cycle

**COP over
6.5
Achieved**

High-efficiency Compressor

Increased compressor efficiency

- 3 dimensional blade impeller (2 stages)
- Vaned diffuser
- Low rotating speed compressor enables the use of low-loss bearing structure.

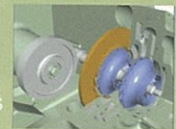

High-performance Heat Exchanger

Increased efficiency resulted from improved performance of heat exchanger

Employment of high-performance heat exchange tubes.
Optimal structural design of heat exchanger to match the behavior of refrigerant.

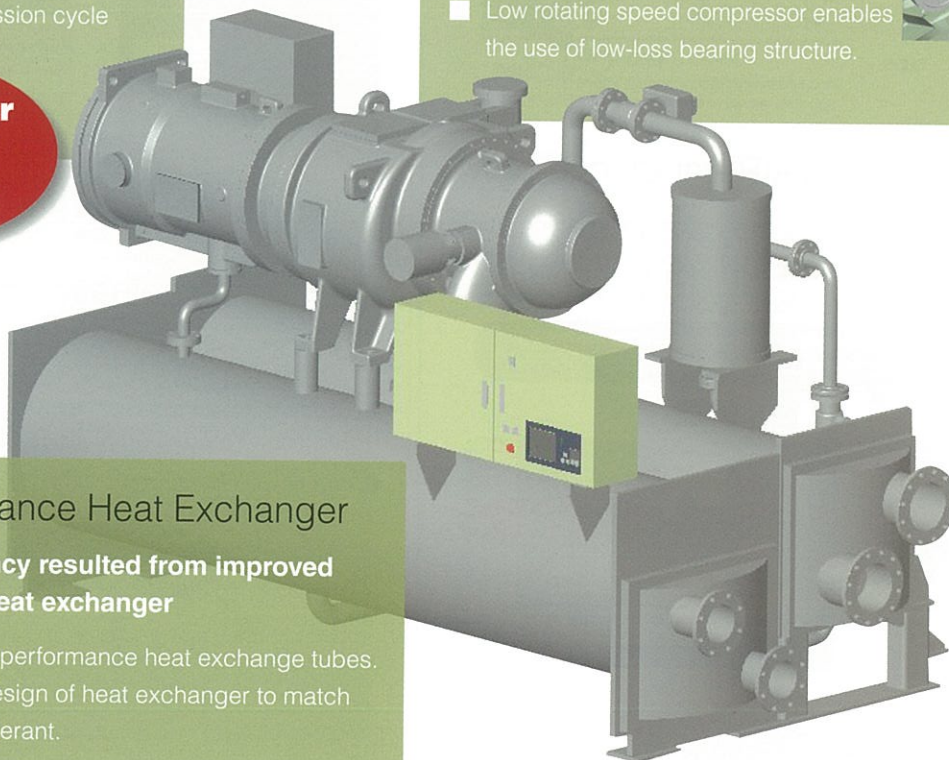

Hitachi's High Technology and Rich Experience Realized Compact, High-Efficiency and High-Reliability Chillers

Top-class Compact Design and Light Weight Design

- The compact design greatly improves flexibility in installation.
- Realizing space saving of machine room.
- Easy carry-in to machine room.
- Suitable for replacement of long-operating chillers.
- Significant reduction of refrigerant volume.

Comparison of Chiller Size (Comparison of 1000RT models)

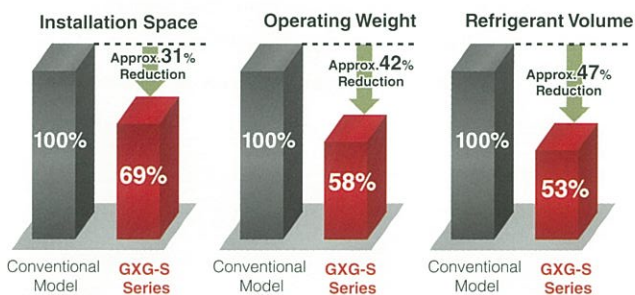

New Type Economizer

Improvement of vapor-liquid separation performance and significant downsizing are realized by the use of Newly-developed economizer. (cyclonic system)

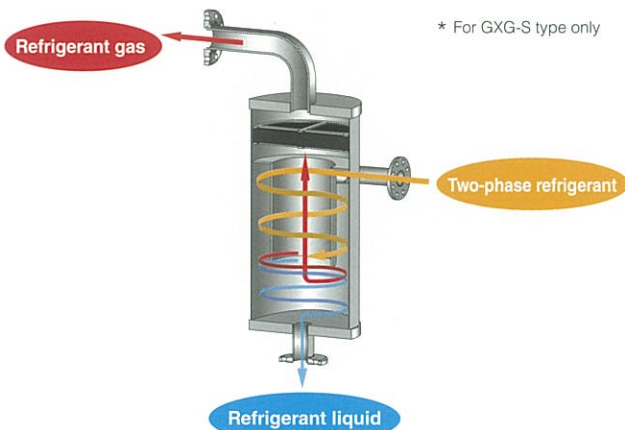

Easy Operation with Touch Panel Type Control Panel

- Monitor various operating data
- Indicate trend graph during operation
- Trend data for max. 40 hours. (Updated every 1 hour)
- Indicate and store Operation history for the past 12 hours (Updated every hour)
- Indicate and store Failure and Alarm history (latest 6 times each)
- Show Handling Guide in case of failure
- Automatic restart function after instantaneous power failure (Option)
- Multilingual Languages Indication (Japanese, English, Chinese [Simplified, Traditional], Portuguese)

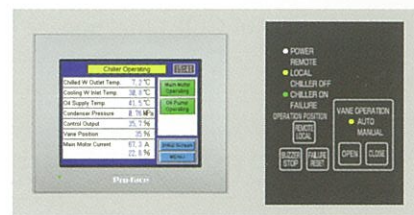

Chiller Operating		15:41
Chilled W Outlet Temp.	7.2 °C	Main Motor Operating
Cooling W Inlet Temp.	30.8 °C	Oil Pump Operating
Oil Supply Temp.	41.5 °C	
Condenser Pressure	0.76 MPa	
Control Output	35.7 %	
Vane Position	35 %	
Main Motor Current	67.3 A	
	22.8 %	

Operation screen

Failure Screen		Fail Indicat.	MENU
Main Motor High Temp	Main Motor Overloaded	Condenser High Press	Evaporator Low Press
Chilled W Overcooled	Oil Supply Low Press	Oil Supply High Temp	Oil Tank Low Temp
Oil Pump Overloaded	Start-up Time Out	Chilled W Suspended	Cooling W Suspended
Water Pump Interlock Abnormal	Ctrl. Sensor Abnormal	Start Panel Abnormal	Emergency Stop

Failure screen

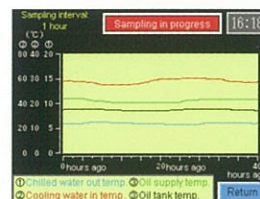

Trend data screen

Main Motor Overloaded / High Temp.	
[Cause] => [Countermeasure]	Return
Power voltage imbalance => Reduce fluctuation	
Power open-phase => Check power cable connection	
Large voltage drop => Check power supply system	
Excessive low-head => Enlarge pressure difference operation between Condenser & Evapo	
Ref. strainer clogging => Clean refrigerant strainer	
Starter panel abnormal => Check starter panel	
Main motor earth (ground) fault => Measure main motor insulation resistance	

Handling guide screen

Flexible Combination of Compressor & Heat Exchangers

- Optimum model selection upon Customer's request for Efficiency, Pressure Drop, Initial Cost, Installation Space, etc.
- Higher COP level can be achieved depending on the combination.

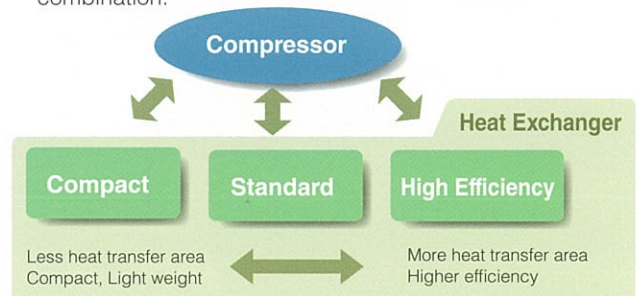

2-stage Compression Cycle

To improve compressor efficiency, refrigerant economizer is added with 2-stage compressor equipped with 2 impellers, as shown in the drawing below. In this case, the refrigerant goes through two expansion devices.

When the refrigerant goes through the first device, some of the refrigerant flashes, or become a gas.

The flashed refrigerant is introduced to the compressor between the two stages. In the one-stage compressor cycle without the economizer, all refrigerant flows in the cycle. Comparatively, in the 2-stage compressor cycle the part of the refrigerant is bypassed from the economizer to the 2-stage impeller.

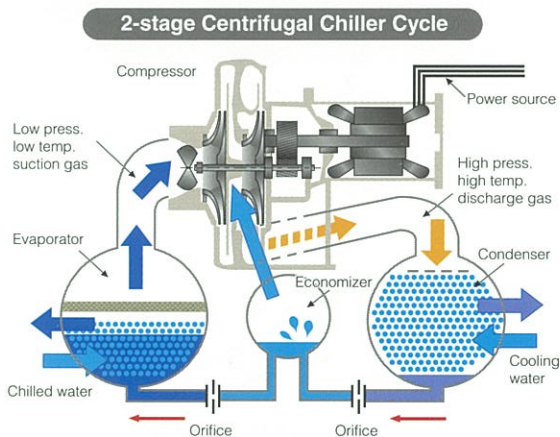

Compatible with BMS

Chiller control panel is equipped with RS485 communication port and compatible with Building Management System through MODBUS RTU protocol.

Communication Item

Operation Condition

- Date (Year/Month/Day)
- Time (Hour/Min./Sec.)
- Chiller (operation/stop)
- Oil pump (operation/stop)
- Oil heater (operation/stop)
- Main motor (operation/stop)
- Low load stop (on/off)
- Restart restriction (on/off)
- Condenser pressure Limit (on/off)
- Failure (presence/absence)
- Chiller operation (remote/local)
- Chiller operating hours
- Main motor operating hours
- Oil pump operating hours
- Oil heater operating hours
- Chiller operation times
- Main motor operation times
- Failure times
- Failure information (*1)

Operation Data

- Chilled water inlet temperature
- Chilled water outlet temperature
- Cooling water inlet temperature
- Cooling water outlet temperature
- Oil supply temperature
- Oil Tank temperature
- Main motor operating current (A)
- Main motor operating current (%)
- Vane position
- Control output for Vane position
- Condenser pressure
- Evaporator pressure
- Oil supply pressure

(*1) Failure Information

- Main motor high temperature
- Main motor overloaded
- High condenser pressure
- Low evaporator pressure
- Chilled water overcooled
- Low oil supply pressure
- High oil supply temperature
- Low oil tank temperature
- Oil pump overloaded
- Start-up time out
- Starter panel abnormal
- Chilled water suspended
- Cooling water suspended
- Water pump interlock abnormal
- Control sensor abnormal
- Emergency stop

High Reliability Design

Direct refrigerant cooling of lubrication oil in oil cooler without cooling water piping increases reliability.

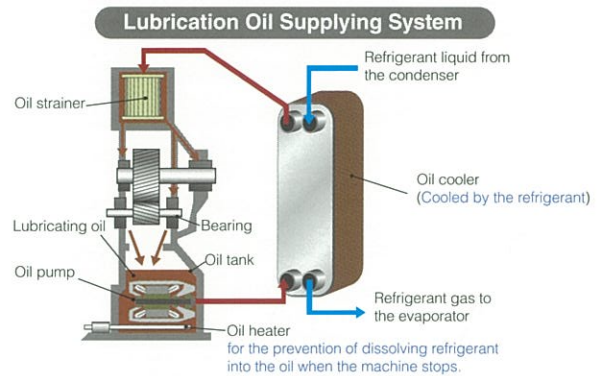

Surge Protection

Adopting strict criteria specified in JIS for stable operation under high cooling water temperature. 3D 2-stage impeller enables stable operation even at low cooling load or high cooling water inlet temp. which prevents occurrence of surge.

Compressor characteristic comparison

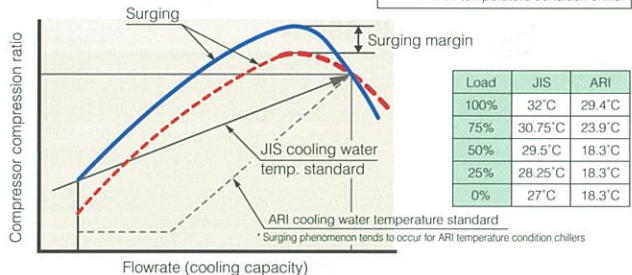

* This figure shows general characteristics and does not provide any guarantees as to the performance.

Wider Operating Range

Stable operation continues even when rise of condenser pressure due to cooling water temperature in hot summer and/ or proceeding of tube fouling.

Example of rising cooling water temperature due to rising ambient temperature.

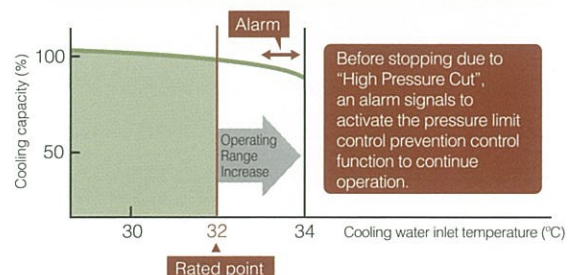

Soft starter is available (Optional)

Soft starter enables smooth start up of motor without large rush current.

General Data

Specifications

■ High Efficiency Type HC-F_GXG-S

Model	Product Code	Cooling Capacity USRT (kW)	COP	Overall Dimension			Shipping Weight kg	Operating Weight kg	Refrigerant Amount kg
				Length (A) mm	Width (B) mm	Height (C) mm			
HC-F300GXG-S	F05EX30CX30	300-349 (1,055-1,227)	5.15-6.16	3,550	1,650	2,200	5,800	7,000	350
HC-F350GXG-S	F05EX30CX30	350-350 (1,231-1,231)	5.15-6.16	3,550	1,650	2,200	5,800	7,100	350
HC-F400GXG-S	F10EX40CX40	351-449 (1,234-1,579)	5.35-6.40	3,550	1,900	2,400	7,000	8,500	450
HC-F450GXG-S	F10EX40CX40	450-450 (1,582-1,582)	5.36-6.41	3,550	1,900	2,400	7,000	8,600	450
HC-F500GXG-S	F20EX50CX50	451-549 (1,586-1,930)	5.58-6.68	4,050	1,900	2,450	8,400	9,900	500
HC-F550GXG-S	F20EX55CX55	550-599 (1,934-2,106)	5.62-6.72	4,050	2,000	2,500	8,700	10,400	600
HC-F600GXG-S	F20EX60CX60	600-649 (2,110-2,282)	5.70-6.82	4,050	2,000	2,500	8,900	10,500	600
HC-F650GXG-S	F20EX60CX60	650-650 (2,285-2,285)	5.63-6.73	4,050	2,000	2,500	9,100	10,900	600
HC-F700GXG-S	F25EX70CX70	651-749 (2,289-2,633)	5.59-6.69	4,050	2,250	2,650	10,700	12,600	700
HC-F750GXG-S	F25EX70CX70	750-799 (2,637-2,809)	5.65-6.75	4,050	2,250	2,650	10,700	12,700	700
HC-F800GXG-S	F25EX80CX80	800-800 (2,813-2,813)	5.74-6.86	4,050	2,250	2,650	11,100	13,300	700
HC-F850GXG-S	F30EX85CX85	801-899 (2,816-3,161)	5.59-6.69	4,050	2,400	2,800	12,200	14,500	880
HC-F900GXG-S	F30EX90CX90	900-949 (3,164-3,337)	5.65-6.75	4,050	2,400	2,800	12,400	14,800	880
HC-F950GXG-S	F30EX90CX90	950-999 (3,340-3,512)	5.66-6.77	4,050	2,400	2,800	12,400	14,900	880
HC-F1000GXG-S	F30EX100CX100	1,000-1,000 (3,516-3,516)	5.81-6.94	4,550	2,400	2,800	13,900	16,900	1,000
HC-F1050GXG-S	F30EX105CX105	1,001-1,099 (3,520-3,864)	5.74-6.86	4,550	2,600	2,900	14,100	17,200	1,100
HC-F1100GXG-S	F30EX110CX110	1,100-1,149 (3,868-4,040)	5.78-6.91	4,550	2,600	2,900	14,300	17,500	1,100
HC-F1150GXG-S	F35EX115CX115	1,150-1,199 (4,043-4,216)	5.79-6.92	4,550	2,600	2,900	14,800	18,100	1,100
HC-F1200GXG-S	F35EX120CX120	1,200-1,249 (4,219-4,391)	5.83-6.97	4,550	2,600	2,900	15,800	19,100	1,100
HC-F1250GXG-S	F35EX120CX120	1,250-1,299 (4,395-4,567)	5.84-6.99	4,550	2,600	2,900	15,800	19,200	1,100
HC-F1300GXG-S	F35EX120CX120	1,300-1,349 (4,571-4,743)	5.85-7.00	4,550	2,600	2,900	15,800	19,300	1,100
HC-F1350GXG-S	F35EX120CX120	1,350-1,399 (4,747-4,919)	5.86-7.01	4,550	2,600	2,900	16,000	19,600	1,100
HC-F1400GXG-S	F35EX120CX120	1,400-1,400 (4,922-4,922)	5.89-7.04	4,550	2,600	2,900	16,000	19,700	1,100
HC-F1500GXG-S (*)	F40EX150CX150	1,401-1,599 (4,926-5,622)	5.74-6.86	4,850	3,300	3,400	20,500	24,300	1,500
HC-F1600GXG-S (*)	F40EX160CX160	1,600-1,600 (5,626-5,626)	5.77-6.90	4,850	3,300	3,400	20,700	24,600	1,500
HC-F1700GXG-S (*)	F50EX170CX170	1,601-1,799 (5,629-6,325)	5.69-6.81	5,250	3,500	3,700	23,700	27,500	1,700
HC-F1800GXG-S (*)	F50EX180CX180	1,800-1,899 (6,329-6,677)	5.73-6.85	5,250	3,500	3,700	24,000	27,900	1,700
HC-F1900GXG-S (*)	F50EX190CX190	1,900-1,999 (6,680-7,028)	5.77-6.90	5,250	3,500	3,700	24,200	28,200	1,700
HC-F2000GXG-S (*)	F50EX200CX200	2,000-2,000 (7,032-7,032)	5.84-6.99	5,250	3,500	3,700	24,500	28,500	1,700

■ Compact Type HC-F_GSG-S

Model	Product Code	Cooling Capacity USRT (kW)	COP	Overall Dimension			Shipping Weight kg	Operating Weight kg	Refrigerant Amount kg
				Length (A) mm	Width (B) mm	Height (C) mm			
HC-F300GSG-S	F05ES30CS30	300-300 (1,055-1,055)	4.60-5.50	2,800	1,750	2,200	5,000	6,200	350
HC-F350GSG-S	F10ES35CS35	301-350 (1,058-1,231)	4.66-5.58	2,900	2,070	2,300	6,200	6,800	350
HC-F400GSG-S	F10ES40CS40	300-400 (1,055-1,406)	4.75-5.68	2,900	2,070	2,300	6,300	7,000	350
HC-F450GSG-S	F20ES45CS45	401-450 (1,410-1,582)	4.78-5.72	3,190	2,070	2,350	7,600	8,500	400
HC-F500GSG-S	F20ES50CS50	451-500 (1,586-1,758)	5.02-6.01	3,190	2,070	2,350	7,600	8,500	400
HC-F550GSG-S	F20ES55CS55	501-550 (1,762-1,934)	5.00-5.97	3,190	2,080	2,350	7,700	8,700	420
HC-F600GSG-S	F20ES60CS60	551-600 (1,937-2,110)	5.03-6.02	3,190	2,080	2,350	7,800	8,800	420
HC-F650GSG-S	F20ES65CS65	601-650 (2,113-2,285)	5.07-6.06	3,490	2,090	2,430	9,200	10,600	530
HC-F700GSG-S	F25ES70CS70	651-700 (2,289-2,461)	5.13-6.14	3,490	2,090	2,430	9,300	10,700	530
HC-F750GSG-S	F25ES75CS75	701-750 (2,465-2,637)	5.17-6.18	3,490	2,350	2,540	10,000	11,400	600
HC-F800GSG-S	F30ES80CS80	751-800 (2,641-2,813)	5.34-6.38	3,490	2,350	2,560	10,800	12,300	630
HC-F850GSG-S	F30ES85CS85	801-850 (2,816-2,989)	5.38-6.44	3,490	2,370	2,560	10,900	12,500	630
HC-F900GSG-S	F30ES90CS90	851-900 (2,992-3,164)	5.39-6.45	3,490	2,370	2,560	11,000	12,600	630
HC-F950GSG-S	F30ES95CS95	901-950 (3,168-3,340)	5.19-6.20	3,740	2,590	2,650	12,200	14,200	800
HC-F1000GSG-S	F30ES100CS100	951-1,000 (3,344-3,516)	5.23-6.25	3,740	2,590	2,650	12,300	14,300	800
HC-F1050GSG-S	F30ES105CS105	1,001-1,050 (3,520-3,692)	5.26-6.29	3,740	2,590	2,650	12,400	14,500	800
HC-F1100GSG-S	F35ES110CS110	1,051-1,100 (3,695-3,868)	5.29-6.33	3,740	2,590	2,710	13,000	15,100	800
HC-F1150GSG-S	F35ES115CS115	1,101-1,150 (3,871-4,043)	5.33-6.37	3,740	2,590	2,710	13,100	15,200	800
HC-F1200GSG-S	F35ES120CS120	1,151-1,200 (4,047-4,219)	5.35-6.39	3,740	2,590	2,710	13,200	15,300	850
HC-F1250GSG-S	F35ES125CS125	1,201-1,250 (4,223-4,395)	5.38-6.44	3,740	2,590	2,710	13,300	15,400	850
HC-F1300GSG-S (*)	F40ES130CS130	1,251-1,300 (4,399-4,571)	5.37-6.42	4,700	3,300	3,400	18,600	21,600	1,150
HC-F1350GSG-S (*)	F40ES135CS135	1,301-1,350 (4,574-4,747)	5.38-6.44	4,700	3,300	3,400	18,700	21,700	1,150
HC-F1400GSG-S (*)	F40ES140CS140	1,351-1,400 (4,750-4,922)	5.38-6.44	4,700	3,300	3,400	18,800	21,800	1,150
HC-F1450GSG-S (*)	F40ES145CS145	1,401-1,450 (4,926-5,098)	5.39-6.45	4,700	3,300	3,400	18,900	22,000	1,150
HC-F1500GSG-S (*)	F40ES150CS150	1,451-1,500 (5,102-5,274)	5.40-6.46	4,700	3,300	3,400	19,000	22,100	1,150
HC-F1600GSG-S (*)	F50ES160CS160	1,501-1,600 (5,278-5,626)	5.47-6.55	5,000	3,500	3,700	21,000	24,700	1,500
HC-F1700GSG-S (*)	F50ES170CS170	1,601-1,700 (5,629-5,977)	5.46-6.53	5,000	3,500	3,700	21,200	25,000	1,500
HC-F1800GSG-S (*)	F50ES180CS180	1,701-1,800 (5,981-6,329)	5.39-6.45	5,000	3,500	3,700	21,500	25,400	1,500
HC-F1900GSG-S (*)	F50ES190CS190	1,801-1,900 (6,332-6,680)	5.46-6.52	5,000	3,500	3,700	21,700	25,700	1,500
HC-F2000GSG-S (*)	F50ES200CS200	1,901-2,000 (6,684-7,032)	5.49-6.57	5,000	3,500	3,700	22,000	26,000	1,500

REMARKS

- * Please consult with our sales staff or distributor for actual specifications for cooling capacity, expected kW input, and COP, depending on selected operating parameters.
- * The above Specifications are subject to change without notice for technical improvements. * This table is applicable to chillers to be manufactured for normal water.
- * Capacity control range is 100% to approx. 20%. * Fouling factor is assumed to be 0.018m²K/kW for chilled water and 0.044m²K/kW for cooling water.
- * Standard main power sources: 380V/400V/415V/440V/460V (up to F1250GSG-S & F1400GXG-S), 3000V/3300V/6000V/6600V (any capacity), 10000V/11000V (F800GSG-S & F900GXG-S and above) AC, 50Hz/60Hz, 3phase.
- * Maximum working pressure is 1.0MPa for both chilled water and cooling water. If higher maximum working pressure is required, please specify during inquiry. (Up to 2MPa is available.)
- * Up to 2000USRT model can be supplied, please consult with our sales staff or distributor.
- * The above tables show the specification of low voltage (380-460V) models. (*1 HC-F1300~2000GSG-S, HC-F1500~2000GXG-S: specification for high voltage models.)



Standard Scope of Supply

The following table shows the standard scope of supply, but the actual scope depends on the contract.

Please consult with our sales staff or distributor.

Item	Standard Scope
Main Equipment	Compressor, Main motor, Lubrication system, Heat exchanger
Auxiliary Equipment	Safety device, Control panel, Standard accessories (Corrugated rubber vibration insulator plates, Oil strainer elements, Gasket for oil strainer elements, Dryer), Starter (optional)
Coating	Chiller main unit: Anti-corrosive prime coating Control panel: Finish coat (color: Munsell 5Y8/1 gloss) Starter (optional): Finish coat (color: Munsell 5Y7/1 semigloss)
Out of Supply Scope	Foundation work, Carrying-in, Installation, Piping work, Cold insulation, Primary and secondary side electrical wiring, Commissioning for total system, Forced ventilation system, Outdoor discharge piping for safety valve, Counter flange, Bolt, Nut, Gasket, Foundationbolt, Refrigerant

Optional Items

- Min. cooling water inlet temperature 12°C (GXG-S), and 15°C (GSG-S)
- Variable chilled water flow rate (chilled water/cooling water)
- Max. working pressure up to 2.0MPa (evaporator/condenser)
- Min. cooling capacity 10%
- Marine type/hinged type water box (evaporator/condenser)
- Delivery in knockdown form (3 pieces – compressor, heat exchangers, control panel, 4 pieces)

Dimensional Outline Drawing

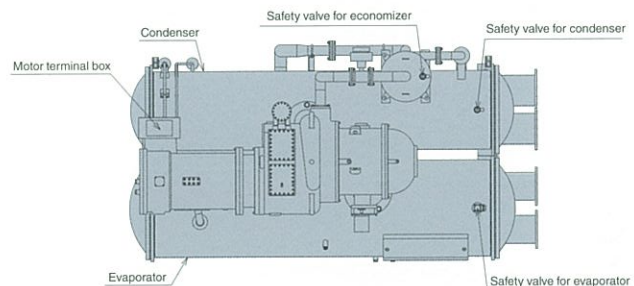
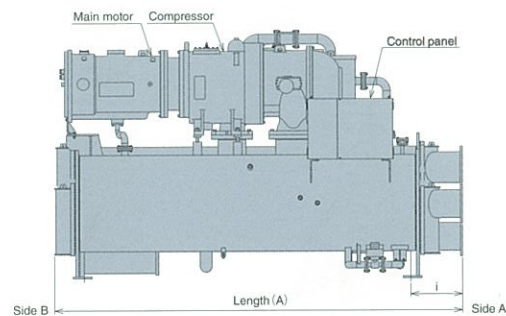
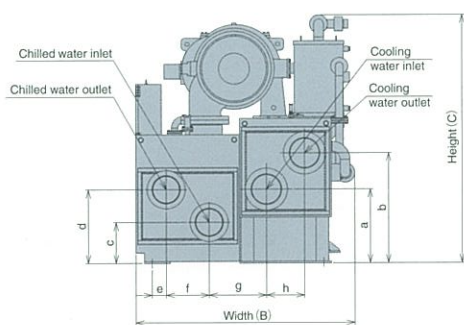

This dimensional outline drawing shows a standard nozzle location. Please consult with our sales staff or distributor in case of a 3-pass or 4-pass system.

■ Positional Dimension of Water Piping

Model	Positional dimension of nozzle								
	a	b	c	d	e	f	g	h	i
HC-F300GXG-S	673	933	398	616	33	339	444	290	420
HC-F350GXG-S	673	933	398	616	33	339	444	290	420
HC-F400GXG-S	715	975	442	642	101	358	525	292	420
HC-F450GXG-S	715	975	442	642	101	358	525	292	420
HC-F500GXG-S	714	974	462	662	101	358	525	292	420
HC-F550GXG-S	734	1,027	474	695	102	400	535	320	420
HC-F600GXG-S	734	1,027	494	715	102	400	535	320	420
HC-F650GXG-S	734	1,027	494	715	102	400	535	320	420
HC-F700GXG-S	810	1,155	490	730	107	500	562	380	420
HC-F750GXG-S	810	1,155	490	730	107	500	562	380	420
HC-F800GXG-S	810	1,155	490	730	107	500	562	380	420
HC-F850GXG-S	780	1,160	435	795	139	480	640	380	420
HC-F900GXG-S	780	1,160	455	815	139	480	640	380	420
HC-F950GXG-S	780	1,160	455	815	139	480	640	380	420
HC-F1000GXG-S	780	1,160	475	835	139	480	640	380	420
HC-F1050GXG-S	858	1,278	436	816	164	500	668	444	420
HC-F1100GXG-S	858	1,278	456	836	164	500	668	444	420
HC-F1150GXG-S	858	1,278	456	836	164	500	668	444	420
HC-F1200GXG-S	858	1,278	475	855	164	500	668	444	420
HC-F1250GXG-S	858	1,278	475	855	164	500	668	444	420
HC-F1300GXG-S	858	1,278	490	840	164	500	668	444	420
HC-F1350GXG-S	858	1,278	490	840	164	500	668	444	420
HC-F1400GXG-S	858	1,278	490	840	164	500	668	444	420
HC-F1500GXG-S	974	1,474	543	983	267	580	935	500	620
HC-F1600GXG-S	974	1,474	562	1,002	267	580	935	500	620
HC-F1700GXG-S	1005	1,565	603	1,043	269	700	897	580	620
HC-F1800GXG-S	1005	1,565	603	1,043	269	700	897	580	620
HC-F1900GXG-S	1005	1,565	623	1,063	269	700	897	580	620
HC-F2000GXG-S	1005	1,565	623	1,063	269	700	897	580	620

(unit: mm)

Model	Positional dimension of nozzle								
	a	b	c	d	e	f	g	h	i
HC-F300GSG-S	432	632	340	540	130	358	530	358	405
HC-F350GSG-S	432	632	359	559	130	358	530	358	405
HC-F400GSG-S	432	632	359	559	130	358	530	358	405
HC-F450GSG-S	378	673	352	532	118	352	619	358	405
HC-F500GSG-S	378	673	352	532	118	352	619	358	405
HC-F550GSG-S	378	673	352	532	115	358	616	358	405
HC-F600GSG-S	378	673	352	532	115	358	616	358	405
HC-F650GSG-S	432	727	387	607	135	358	618	358	409
HC-F700GSG-S	432	727	387	607	135	358	618	358	409
HC-F750GSG-S	404	719	361	661	154	415	704	410	409
HC-F800GSG-S	404	719	380	680	154	415	704	410	409
HC-F850GSG-S	404	719	380	680	154	415	704	410	409
HC-F900GSG-S	404	719	380	680	154	415	704	410	409
HC-F950GSG-S	484	784	370	670	183	500	675	500	409
HC-F1000GSG-S	484	784	370	670	183	500	675	500	409
HC-F1050GSG-S	484	784	390	690	183	500	675	500	409
HC-F1100GSG-S	484	784	390	690	183	500	675	500	409
HC-F1150GSG-S	484	784	410	710	183	500	675	500	409
HC-F1200GSG-S	484	784	410	710	183	500	675	500	409
HC-F1250GSG-S	484	784	410	710	183	500	675	500	409
HC-F1300GSG-S	979	1469	523	963	257	600	925	500	612
HC-F1350GSG-S	979	1469	523	963	257	600	925	500	612
HC-F1400GSG-S	979	1469	523	963	257	600	925	500	612
HC-F1450GSG-S	979	1469	543	983	257	600	925	500	612
HC-F1500GSG-S	979	1469	543	983	257	600	925	500	612
HC-F1600GSG-S	685	1125	584	1024	269	700	835	700	620
HC-F1700GSG-S	685	1125	584	1024	269	700	835	700	620
HC-F1800GSG-S	685	1125	603	1043	269	700	835	700	620
HC-F1900GSG-S	685	1125	603	1043	269	700	835	700	620
HC-F2000GSG-S	685	1125	623	1063	269	700	835	700	620



HITACHI

Hitachi Appliances, Inc.

URL : <http://www.hitachi-ap.com>

Distributed by